

Applications

Agilent Technologies broadband detectors¹ span frequencies from 100 kHz to 50 GHz. These detectors are widely used on the design and production test bench, as well as for internal components of test system signal interface units. They find use in a variety of test and measurement applications.

- Power monitoring
- Source leveling
- Video detection
- Swept transmission and reflection measurements

Technology

Agilent detectors are available in two families – Silicon Low Barrier Schottky Diode (LBSD) and Gallium Arsenide Planar Doped Barrier Diode (GaAs PDBD) detectors. The Gallium Arsenide detector technology produces diodes with extremely flat frequency response to 50 GHz. Also, the GaAs PDB detector has a wider operating temperature range (-65 °C to +100 °C), and is less sensitive to temperature changes.

Key specifications:

- Frequency range
- Frequency response
- Open circuit voltage sensitivity
- Tangential sensitivity
- Output voltage versus temperature
- Rise time
- SWR
- Square-law response
- Input power

Frequency range

Frequency range can be one of the most important factors to consider when specifying detectors. In the past, broadband frequency coverage was equated with high performance. It is important to note that though broadband coverage may be desirable in multi-octave applications, a good octave range detector may be your best solution for non-swept applications. Broadband coverage saves you from the inconvenience of having to switch between detectors when making measurements, but you may be sacrificing SWR and frequency response flatness. All of Agilent’s 8474 family of coaxial detectors are available in both octave band and broadband versions. The guaranteed performance of the octave band models are characterized for frequency response flatness and SWR.

¹ See Waveguide chapter for additional products.

Frequency response

Frequency response is the variation in output voltage versus frequency, with a constant input power. Frequency response is referenced to the lowest frequency of the band specified. Agilent typically uses -30 dBm to measure frequency response. Agilent uses precision thin-film input circuitry to provide good, broadband input matching. Exceptionally flat frequency response is provided by the very low internal capacitance of the PDB diode. Also, excellent control of the video resistance of the PDB diode is obtained by the precision growth of molecular beam epitaxy (MBE) layers during diode fabrication.

Figure 1 displays frequency response characteristics comparing Agilent LBSD and PDBD detectors. The figure indicates typical performance of each device and the published specifications. Frequency response specifications include the mismatch effects of the detector input SWR specifications. Note that the Agilent 8474E, representative of PDB detectors, is exceptionally flat beyond 26.5 GHz.

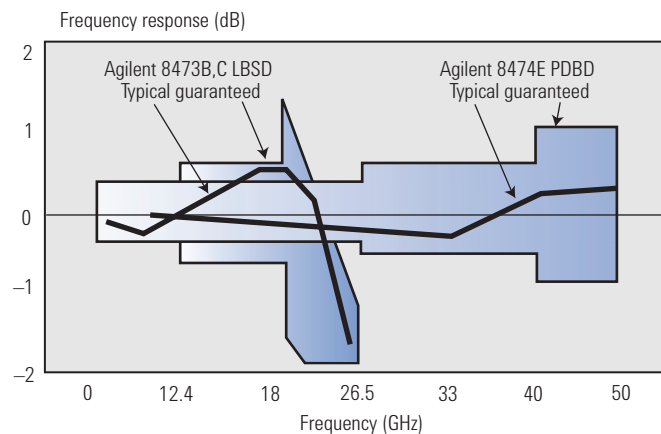

Figure 1. Detector frequency response characteristics.

Open circuit voltage sensitivity

The open circuit voltage sensitivity (K) describes the slope of the transfer function of the detectors. This represents the conversion of RF/microwave power to a voltage at the output connector, typically specified in mV/mW. The value is an indication of the efficiency of the diode in converting the input power to a useful voltage.

Sensitivity is measured with the detector terminated in a high impedance. When used in video pulse applications, the sensitivity will appear to be much lower when terminated in 50 or 75 ohms for connection to an oscilloscope. Another factor, called the Figure of Merit, gives an indication of low-level sensitivity without consideration of a load circuit. It is useful for comparing detectors with different values of K and R_V . Figure of Merit equals $K/\sqrt{R_V}$, where R_V = internal video resistance.

Tangential sensitivity

Tangential sensitivity is the lowest input signal power level for which the detector will have an 8 dB signal-to-noise ratio at the output of a test video amplifier. Test amplifier gain is not relevant because it applies to both signal and noise. Agilent detectors are designed for optimal flatness and SWR. Figure 2 shows typical tangential sensitivity.

$$P_{tss} \text{ (watts)} = \frac{3.23 \times 10^{-10} \sqrt{BFR_V}}{K} @ 300 \text{ }^\circ\text{K}$$

Where: B = Video amplifier bandwidth (Hz)
 F = Video amplifier noise factor = 10 (Noise figure/10)
 R_V = Video resistance (Ω)
 K = Open circuit voltage Sensitivity (mV/mW)

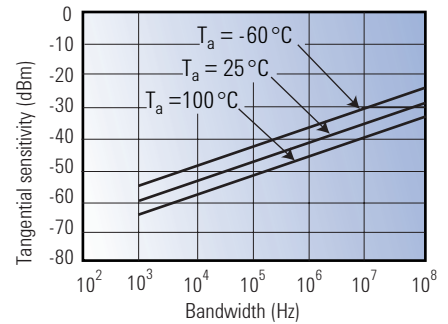

Figure 2. Typical tangential sensitivity performance.

Output voltage versus temperature

For applications such as power monitoring and leveling that require stable output voltage versus input power, the designer can choose a resistive termination that will optimize the transfer function over a wide temperature range. Figure 3 shows how sensitivity changes over temperature with different load resistances. In this case, a value between 1 k Ω and 10 k Ω will be optimum for 0 to 50 $^\circ\text{C}$.

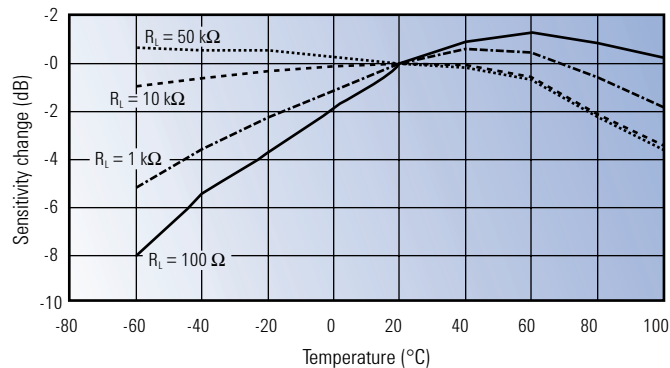

Figure 3. Typical output response with temperature ($P_{in} < -20 \text{ dBm}$) (Schottky diode).

Rise time

In applications where the frequency response of another microwave device is being measured, or where a fast rise time response is required for accurate measurements, the rise time of the detector becomes very important. It is critical to note that the rise time is dependent upon the characteristics of the detector AND the test equipment.

Figure 4 shows the typical equivalent circuit of a test detector, and can help in devising the external terminations and cables to connect to an oscilloscope or other instrument. The following equation gives the approximate rise time for different conditions of load resistance and capacitance. Note that rise time can be improved (lowered) with a termination less than 50 Ω. This rise time improvement comes at the expense of lower pulse output voltage. The lower voltage can be overcome with the gain of a high performance oscilloscope.

$$T_r \text{ (10% to 90%)} = \frac{2.2 \cdot R_L \cdot R_v \cdot (C_L + C_b)}{R_L + R_v} = \frac{0.35}{BW}$$

Where	Determined by
R_L = Load impedance	Measuring equipment
R_v = Video impedance	Detector
C_L = Load capacitance	Measuring equipment
C_b = Bypass capacitance	Detector

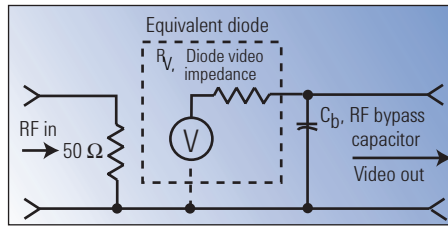

Typical values:

R_v (diode video impedance) = 1.5 kΩ¹
 C_b (RF bypass capacitor) = 27 pF nom.

¹ @ 25 °C and $P_{in} < -20$ dBm.
 Extremely sensitive to power and temperature.

Figure 4. Detector model.

Broadband match (SWR)

In many applications, the match (SWR) of the detector is of prime importance in minimizing the uncertainty of power measurement. If the input of the detector is not well matched to the source, simple and multiple mismatch errors will result, which reduces the accuracy of the measurement.

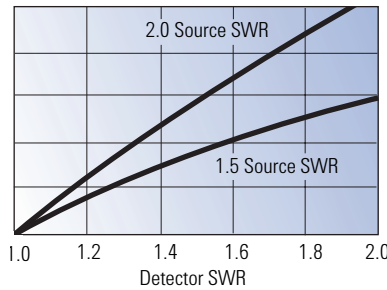

Figure 5. Mismatch error from detector and source mismatch.

Figure 5 represents the mismatch error introduced by multiple reflections caused by mismatch between the detector and the source. For a detector SWR of 2.0 and source SWR of 2.0, this uncertainty is ±1.0 dB. For the LBSD and PDBD models, the integration of the diode with the 50 Ω matching resistor results in excellent broadband match. Both LBSD and PDBDs utilize thin-film technology which yields a precision matching circuit that minimizes stray reactance and yields very good performance. Figure 6 displays typical SWR for the Agilent 8473B,C LBSD detector and the Agilent 8473D PDBD detector.

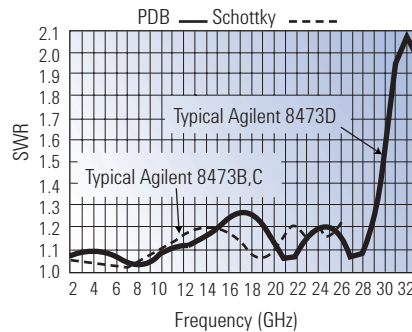

Figure 6. Typical SWR of detectors.

Square law performance

When detectors are used in reflectometer and insertion loss setups, the measurement uncertainty depends on the output voltage being proportional to input power. The term square law comes from the output voltage being proportional to the input power (input voltage squared). Most microwave detectors are inherently square law from the P_{TSS} level up to about -15 dBm. Figure 7 shows this characteristic.

Figure 8 shows detector output in dB relative to $P_{in} = -20$ dBm. As P_{in} exceeds -20 dBm, the detector response deviates from square law. The user can select a load resistor that will extend the upper limit of the square law range beyond ± 15 dBm. By choosing Option 002, 102 (optional square law load), the deviation from ideal square law response will be ± 0.5 dB (although the sensitivity specification is decreased by a factor of 4).

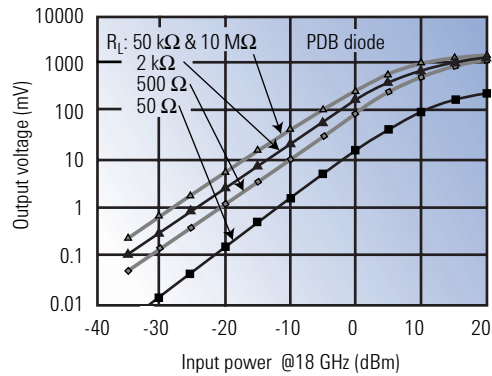

Figure 7. Typical detector square law response (mV).

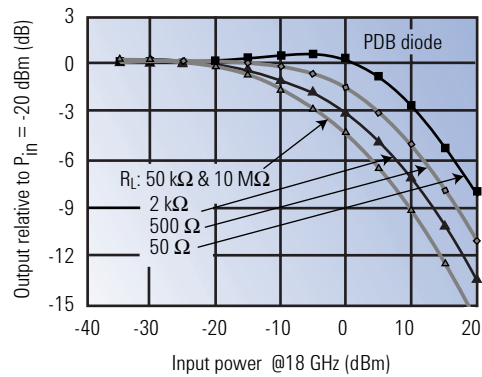

Figure 8. Typical detector square law response (dB).



Agilent 423B

Low-barrier Schottky diode detectors

Agilent 423B, 8470B, 8472B, 8473B,C 33330B,C LBSD detectors have been widely used for many years in a variety of applications including leveling and power sensing. They offer good performance and ruggedness. Matched pairs (Option 001) offer very good detector tracking. A video load option (Option 002) extends the square law region to at least 0.1 mW (-10 dBm).

Agilent 8471D,E



Planar-doped barrier detectors

Agilent 8471D,E detectors are planar-doped barrier detectors offering excellent performance to 2 and 12 GHz. The Agilent 8471D covers 100 kHz to 2 GHz with a BNC (m) input connector and the Agilent 8471E covers 10 MHz to 12 GHz with a SMA (m) input connector. Both detectors come standard with negative polarity output, a positive polarity output is available as Option 103.

High performance planar-doped barrier detectors

Agilent 8474B,C,E and 33330D detectors are the newest additions to the Agilent family of high performance detectors. Utilizing a gallium arsenide, planar-doped barrier detecting diode, these detectors offer superior performance when compared to Schottky diodes. They feature extremely flat frequency response (typically better than ± 1 dB to 50 GHz) and very stable frequency response versus temperature.

These detectors are available with type-N, 3.5-mm, or 2.4-mm connectors. They are also offered with an option for positive output polarity (Option 103). Additionally, some detectors have an optimal square law load available (Option 102).

For applications requiring an octave band or less, Agilent 8474B,C,E detectors are available with frequency band options that feature lower SWR and flatter frequency response.



Agilent 8472B

Agilent 8473D



Agilent 8474 family



Specifications

Agilent model	8471D	8471E	8473D	8474B	8474C	8474E	33330D
Frequency range (GHz)	0.0001 to 2	0.01 to 12	0.01 to 33	0.01 to 18	0.01 to 33	0.01 to 50	0.01 to 33
Frequency response (dB)	±0.2 to 1 GHz ±0.4 to 2 GHz	±0.23 to 4 GHz ±0.6 to 8 GHz ±0.85 to 12 GHz	±0.25 to 14 GHz ±0.4 to 26.5 GHz ±1.25 to 33 GHz	±0.35 to 18 GHz	±0.4 to 26.5 GHz ±0.7 to 33 GHz	±0.3 to 26.5 GHz ±0.6 to 40 GHz ±1.0 to 50 GHz	±0.25 to 14 GHz ±0.4 to 26.5 GHz ±1.25 to 33 GHz
Maximum SWR	1.23 to 1 GHz 1.46 to 2 GHz	1.2 to 4 GHz 1.7 to 8 GHz 2.4 to 12 GHz	1.2 to 14 GHz 1.4 to 26.5 GHz 3.0 to 33 GHz	1.3 to 18 GHz	1.4 to 26.5 GHz 2.2 to 33 GHz	1.2 to 26.5 GHz 1.6 to 40 GHz 2.8 to 50 GHz	1.2 to 14 GHz 1.4 to 26.5 GHz 3.0 to 33 GHz
Low-level sensitivity (mV/μW)	>0.5	>0.5	>0.5	>0.4	>0.4	>0.4 to 40 GHz >0.34 to 50 GHz	>0.4
Maximum operating input power	100 mW	← 200 mW →		← 200 mW →			
Typical short term maximum input power (<1 minute)	0.7 W	0.7 W	← 1 W →		← 1 W →		
Video impedance (nom)	← 1.5 kΩ →				← 1.5 kΩ →		
RF bypass capacitance (nom)	6800 pF	← 30 pF →		← 30 pF →			
Output polarity	← Negative →				← Negative →		
Input connector	BNC (m)	SMA (m)	3.5 mm (m)	Type-N (m)	3.5 mm (m)	2.4 mm (m)	3.5 mm (m)
Output connector	BNC (f)	SMC (m)	BNC (f)	BNC (f)	SMC (m)	SMC (m)	SMC (m)

Options

Agilent model	8471D	8471E	8473D	8474B	8474C	8474E	33330D
Optimal square law load ¹	Opt. 102	N/A	N/A	Opt. 102	N/A	N/A	N/A
Positive polarity output	Opt. 103	Opt. 103	N/A	Opt. 103	Opt. 103	Opt. 103	Opt. 003
Frequency band	N/A	N/A	N/A	See PDBD Frequency Band Options table on page 56			N/A

¹ Defined as ±0.5 dB from ideal square law response.

Specifications

Agilent model	423B	8470B	8472B	8473B	8473C
Freq. range (GHz)	0.01 to 12.4	0.01 to 18	0.01 to 18	0.01 to 18	0.01 to 26.5
Freq. response (dB) (±0.2 dB over any octave from 0.01 to 8 GHz on all models)	±0.3 to 12.4 GHz	±0.3 to 12.4 GHz ±0.5 to 15 GHz ±0.6 to 18 GHz	±0.3 to 12.4 GHz ±0.5 to 15 GHz ±0.6 to 18 GHz	±0.3 to 12.4 GHz ±0.6 to 18 GHz	±0.3 to 12.4 GHz ±0.6 to 20 GHz ±1.5 to 26.5 GHz ¹
Maximum SWR (measured at -20 dBm)	1.15 to 4 GHz 1.3 to 12.4 GHz	1.15 to 4 GHz 1.3 to 15 GHz	1.15 to 4 GHz 1.35 to 7 GHz 1.5 to 12.4 GHz 1.7 to 18 GHz	1.2 to 4 GHz 1.5 to 18 GHz	1.2 to 4 GHz 1.5 to 18 GHz 2.2 to 26.5 GHz
Low-level sensitivity (mV/μW)	>0.5	>0.5	>0.5	>0.5	>0.5 to 18 GHz >0.18 to 26.5 GHz
Maximum operating input power	← 200 mW →				
Typical short term maximum input power (< 1 minute)	← 1 W →				
Noise	← <50 μV →				
Video impedance (nom)	← 1.3 kΩ →				
RF bypass capacitance (nom)	← 30 pf →				
Output polarity	← Negative →				
Input connector	Type-N (m)	APC-7 (m)	SMA (m)	3.5 mm (m)	3.5 mm (m)
Output connector	BNC (f)	BNC (f)	BNC (f)	BNC (f)	BNC (f)

Options

Agilent model	423B	8470B	8472B	8473B	8473C
Matched response² (Option 001)	±0.2 dB to 12.4 GHz	±0.2 dB to 12.4 GHz ±0.3 dB to 18 GHz	±0.2 dB to 12.4 GHz ±0.3 dB to 18 GHz	±0.2 dB to 12.4 GHz ±0.3 dB to 18 GHz	±0.2 dB to 12.4 GHz ±0.3 dB to 18 GHz ±0.5 dB to 26.5 GHz
Optimal square law load³	Option 002	Option 002	Option 002	Option 002	Option 002
Positive polarity output	Option 003	Option 003	Option 003	Option 003	Option 003
Connector		Option 012 Type-N (m) input connector	Option 100 OSSM (f) output connector		
Field replaceable detector elements standard:	00423-60003	08470-60012	08470-60012	08473-80001	08473-80004
Option 001	00423-60007	08470-60016	08470-60016	08473-80002	08473-80005
Option 002	00423-60005	08470-60014	08470-60014	08473-80003	08473-80006
Option 003	00423-60004				

¹ From a -3.3 dB linear slope beginning @ 20 GHz.

² Must order a quantity of 2 standard units and 2 Option 001s for a pair of detectors with matched frequency response.

³ Defined as ±0.5 dB from ideal square law response.

Agilent 8474B options	002	004	008	012	018	
Frequency range (GHz)	0.01 to 2	2 to 4	4 to 8	8 to 12.4	12.4 to 18	
Frequency response (dB)	±0.25	±0.25	±0.25	±0.25	±0.30	
Maximum SWR	1.09	1.1	1.2	1.3	1.3	
Agilent 8474C options	004	008	012	018	026	033
Frequency range (GHz)	2 to 4	4 to 8	8 to 12.4	12.4 to 18	18 to 26.5	26.5 to 33
Frequency response (dB)	±0.2	±0.2	±0.25	±0.3	±0.3	±0.3
Maximum SWR	1.1	1.16	1.2	1.3	1.4	2.2
Agilent 8474E options	026	040	050			
Frequency range (GHz)	18 to 26.5	26.5 to 40	33 to 50			
Frequency response (dB)	±0.3	±0.5	±0.8			
Maximum SWR	1.2	1.6	2.8			

Outline drawings

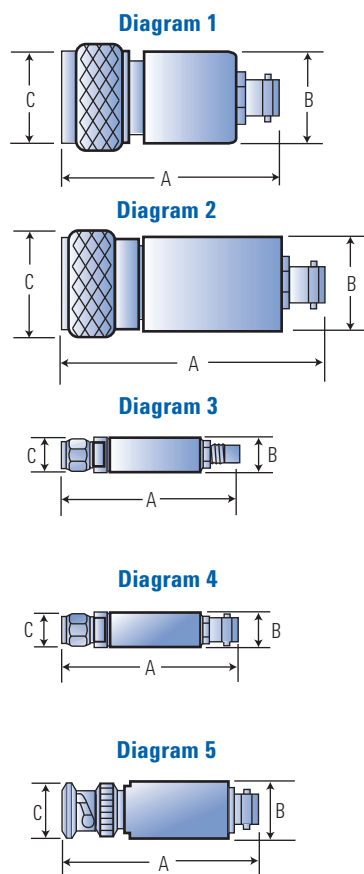

Agilent model	Length (Dim A)	Barrel diameter (Dim B)	Input connector diameter (Dim C)	Net weight	Shipping weight
Diagram 1					
423B	63 mm (2.47 in)	20 mm (0.78 in)	21 mm (0.82 in)	114 g (4 oz)	454 g (16 oz)
8474B	60 mm (2.36 in)	19 mm (0.74 in)	21 mm (0.82 in)	85 g (3 oz)	454 g (16 oz)
Diagram 2					
8470B	62 mm (2.50 in)	19 mm (0.75 in)	22 mm (0.87 in)	114 g	(4 oz) 454 g (16 oz)
Diagram 3					
8471E	39 mm (1.54 in)	9.3 mm (0.36 in)	7.9 mm (0.31 in)	39 g (2 oz)	227 g (8 oz)
8474C	41 mm (1.62 in)	9.7 mm (0.38 in)	7.9 mm (0.31 in)	14 g (0.5 oz)	227 g (8 oz)
Diagram 4					
8472B	64 mm (2.50 in)	14 mm (0.56 in)	7.9 mm (0.31 in)	57 g (2 oz)	227 g (8 oz)
8473B	48 mm (1.89 in)	10 mm (0.39 in)	7.9 mm (0.31 in)	57 g (2 oz)	227 g (8 oz)
8473C	48 mm (1.89 in)	10 mm (0.39 in)	7.9 mm (0.31 in)	57 g (2 oz)	227 g (8 oz)
8473D	48 mm (1.89 in)	10 mm (0.39 in)	7.9 mm (0.31 in)	57 g (2 oz)	227 g (8 oz)
Diagram 5					
8471D	63 mm (2.50 in)	16 mm (0.62 in)	14 mm (0.54 in)	43 g (1.5 oz)	454 g (16 oz)

Environmental specifications**Agilent 423B, 8470B, 8472B, 8473B,C, 33330B,C (LBSD)**

Operating temperature:	-20 °C to +85 °C (Except Agilent 423B: 0 °C to +55 °C)
Vibration:	20 g; 80 to 2000 Hz
Shock:	100 g, 11 ms

Agilent 8471D,E, 8473D, 8474B,C,E, 33330D (PDBD)

Operating temperature:	-65 °C to +100 °C (Except Agilent 8474B: 0 °C to +75 °C)
Temperature cycling: (non-operating)	-65 °C to +100 °C; MIL-STD 883, Method 1010
Vibration:	0.6 inches D.A. 10 to 80 Hz; 20 g, 80 to 200 Hz; MIL-STD 883, Method 2007
Shock:	500 g, 0.5 ms; MIL-STD 883, Method 2002
Acceleration:	500 g; MIL-STD 883, Method 2001
Altitude:	50,000 ft (15,240 m); MIL-STD 883, Method 1001
Salt atmosphere:	48 hr, 5% solution; MIL-STD 883, Method 1009
Moisture resistance:	25 °C to 40 °C, 95% RH; MIL-STD 883, Method 1004
RFI:	MIL-STD 461B
ESD:	10 discharges at 25 kV to the body, not to the center conductor

Agilent 83036C broadband directional detector

This broadband microwave power sampler operates in much the same way as a directional coupler and detector combination. It is comprised of a resistive bridge and PDB diode that yields a very broadband device with excellent frequency response, temperature response and square law response characteristics.

Agilent 83036C



7

Specifications¹

Agilent model	Frequency range (GHz)	Frequency response (dB)	Max. SWR input/output (50 Ω nom)	Maximum thru line loss (dB)	Low level sensitivity	Maximum input power ¹ (into 50 Ω Load)	Maximum input power ¹ (into Open)	Input/output connector
83036C	0.01 to 26.5	±1.0	1.7	2.2	18 μV/μW	32 dBm	21 dBm	3.5 mm (f)

¹ With 2:1 source match.

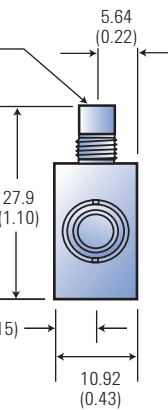
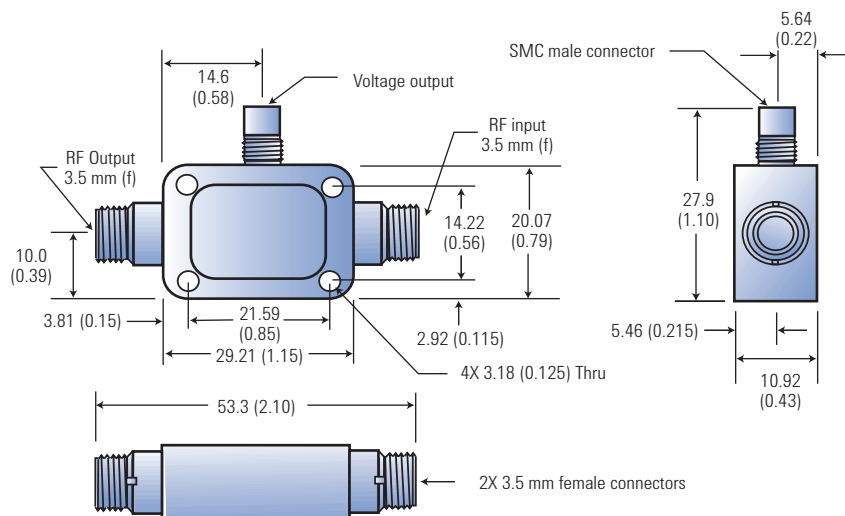

Environmental

Non-operating temperature: -65 to +150 °C

Random vibration: In accordance with MIL-STD-883, Method 2026, Condition IIA: 5.9 g, 50 to 2000 Hz.

Shock: In accordance with MIL-STD-883, Method 2002, Condition B: 1500 g for 0.5 ms.

Moisture resistance: In accordance with MIL-STD-883, Method 1004: 10 cycles, -10 to +65 °C at 90 to 100% RH.

Altitude: In accordance with MIL-STD-883, Method 1001, Condition C: 50,000 ft. operating altitude.